

# **BODYTONE**

USER MANUAL



SOLID ROCK

# **SR03-0**

# **! CAUTION**

**Read all precautions and instructions in this manual before using this equipment.**

## **Table of Contents**

Important Safety Instructions-----	2
Instructions-----	3
Parts List-----	4
Exploded View-----	5
Measurement Guide-----	6
Assembly Instructions-----	7
Assembly-----	8
Maintenance Schedule-----	11
General Maintenance Information-----	12
Weight Training Tips-----	13
Specifications-----	13

## **Important Safety Instructions**

Before beginning any fitness program, you should obtain a complete physical examination from your physician. When using exercise equipment, basic precautions should always be taken, including the following:

- \*Read all instructions before using the equipment. These instructions are written to ensure your safety and to protect the unit.
- \*Do not allow children on or near the equipment.
- \*Use the equipment only for its intended purpose as described in this guide. Do not use accessory attachments that are not recommended by the manufacturer: such attachments might cause injuries.
- \*Wear proper exercise clothing and shoes for your workout---no loose clothing.
- \*Be careful when getting on or off the equipment.
- \*Do not overexert yourself or work to exhaustion.
- \*If you feel any pain or abnormal symptoms, stop your workout immediately and consult your physician.
- \*Never operate the unit when it has been dropped or damaged.
- \*Never drop or insert anything into any opening in the equipment.
- \*Always check the unit and its cables before each use. Make sure that all fasteners and cables are secure and in good working condition.
- \*Frayed or worn cables can be dangerous and may cause injury. Periodically check these cables for any indication of wear.
- \*Keep hands, limbs, loose clothing and long hair well out of the way of moving parts.
- \*Do not attempt to lift more weight than you can control safely.
- \*Do not use the equipment outdoors.

## **Personal Safety During Assembly**

- \*Read each step in the assembly instructions and follow the steps in sequence. Do not skip ahead. If you skip ahead, you may learn later that you have to disassemble components and that you may have damaged the equipment.
- \*Assemble and operate the equipment on a solid, level surface. Locate the unit a few feet from walls or furniture to provide easy access. The equipment is designed for your enjoyment. By following these precautions and using common sense, you will have many safe and pleasurable hours of healthful exercise with the equipment.

## Instructions

Before beginning assembly please take the time to read instructions thoroughly. Please use the various lists in this manual to make sure that all parts have been included in your carton. When ordering, use part number and description from the lists. Use only our replacement part when servicing. Failure to do so will void your warranty and could result in personal injury.

The equipment is designed to provide the smoothest, most effective exercise motion possible. After assembly, you should check all functions to ensure correct operation. If you experience problems, first recheck the assembly instructions to locate any possible errors made during assembly. If you are unable to correct the problem, call your authorized dealer. Be sure to have your serial number and this manual when calling. When all parts have been accounted for, continue on.

## Tools Required

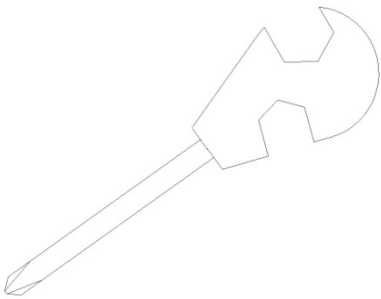

Punch Wrench

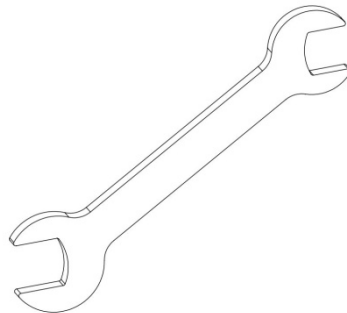

Wrench

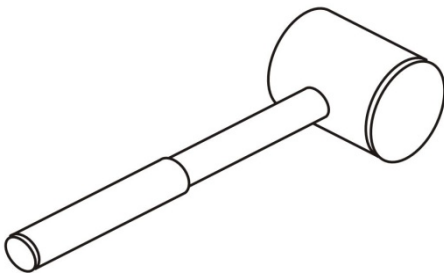

Rubber Mallet

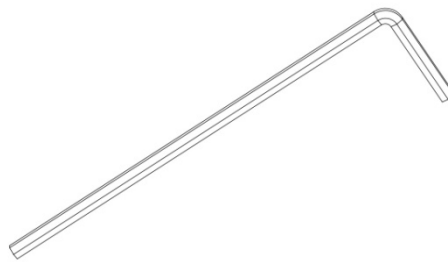

Hex Key Wrench Set

## Parts List

Note: some of these parts may come pre-installed.

ITEM NO.	DESCRIPTION	QTY
1	Bottom Connection Frame	1
2	Back Pad Frame Assembly	1
3	Upper connection Frame	1
4	Lower connection Frame	1
5	Right Bottom Frame	1
6	Left Bottom Frame	1
7	Right Vertical frame	1
8	Left Vertical frame	1
9	Right Arm Frame	1
10	Left Arm Frame	1
11	Seat Support Frame	1
12	Seat Adjustment Frame	1
13	Barbell Plate Rack	2
14	Barbell Plate Rack 2	2
15	Barbell Plate Rack Fixing Plate	2
16	Arc-shaped Connecting Plate	2
17	Reinforcement Plate	2
18	Bearing Rotating Axle	2
19	Rubber Spacer	4
20	Back Pad	1
21	Head Pad	1
22	Seat Pad	1
23	Decorative Cap $\Phi$ 11 $\times$ $\Phi$ 50 $\times$ 8	6
24	Flat Head Cap Screw M10X25	6
25	Flat Head Cap Screw M10X35	9
26	Flat Head Cap Screw M12X25	6
27	Hex Bolt M12X35	16
28	Hex Bolt M12X80	8
29	Hex Bolt M12X85	4
30	Flat Washer $\Phi$ 11 $\times$ $\Phi$ 20 $\times$ 2	9
31	Spring Plate $\Phi$ 12	16
32	Flat Washer $\Phi$ 13 $\times$ $\Phi$ 24 $\times$ 2	40
33	Nut M10	9
34	Nut M12	12

# Exploded View

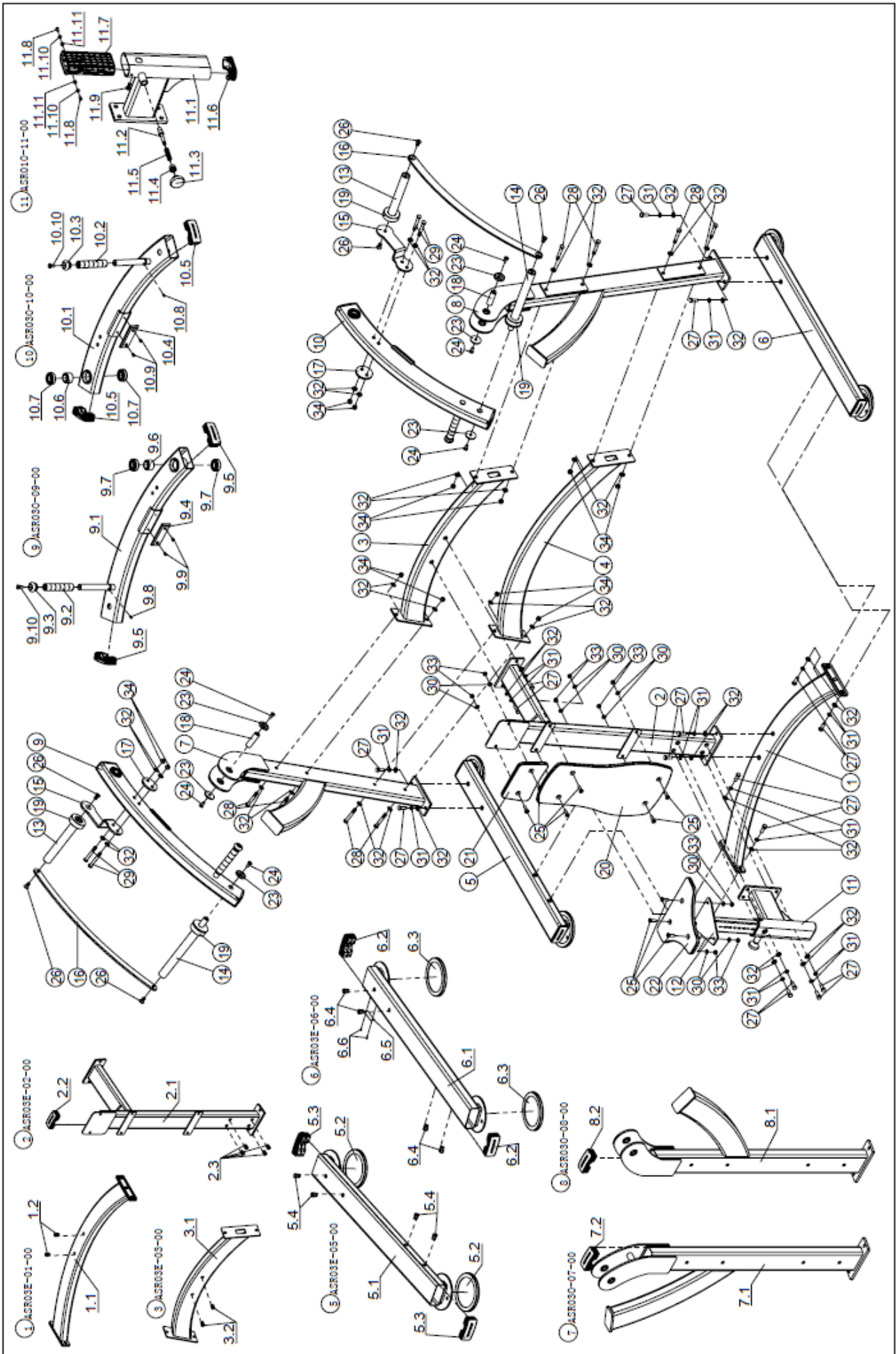

# Measurement Guide

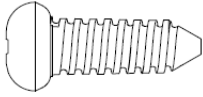

Cross Recessed Pan Head Tapping Screw



Hex Socket Set Screw with Flat Point

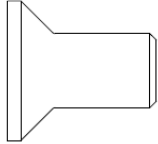

Flat Head Cap Screw

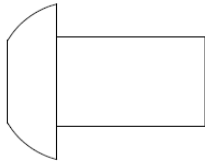

Button Head Cap Screw

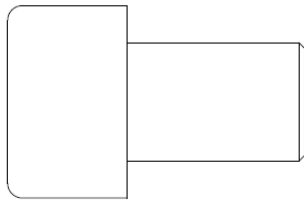

Socket Head Cap Bolt

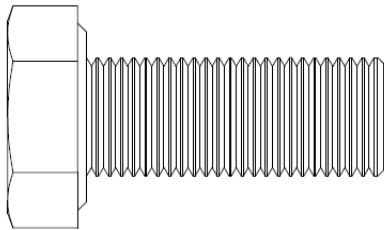

Hex Bolt



## **Assembly Instructions**

Assembly of the equipment takes professional installers about 2 hours. If this is the first time you have assembled this type of equipment, plan to spend more time. It is strongly recommended to assemble the equipment by professional installers. You may find it quicker, safer, and easier to assemble this equipment with the help of a friend, as some of components may be large, heavy or awkward to handle alone. It is important that you assemble your product in a clean, clear, uncluttered area. This will enable you to move around the product while you are fitting components and reduce the possibility of injury during assembly.

Note: As with any assembled part, proper alignment and adjustment is critical. While tightening the fasteners, be sure to leave room for adjustments. Do not fully tighten the fasteners until instructed to do so. Be careful to assemble the components in the sequence presented in this guide.





## Step 2

1. Attach Right Arm Frame (#9) and Left Arm Frame (#10) to Right Vertical frame (#7) and Left Vertical frame (#8) using:  
Two Bearing Rotating Axle (#18)                      Four Decorative Cap  $\Phi 11 \times \Phi 50 \times 8$  (#23)  
Four Flat Head Cap Screw M10X25 (#24)
2. Attach Seat Support Frame (#11) to Back Pad Frame (#2) using:  
Four Hex Bolt M12X35 (#27)                      Four Spring Plate  $\Phi 12$  (#31)  
Four Flat Washer  $\Phi 13 \times \Phi 24 \times 2$  (#32)
3. Attach Seat Adjustment Frame (#12) to Seat Support Frame (#11).

PLEASE MAKE SURE THE BOLTS ARE FASTENED IN GOOD POSITION

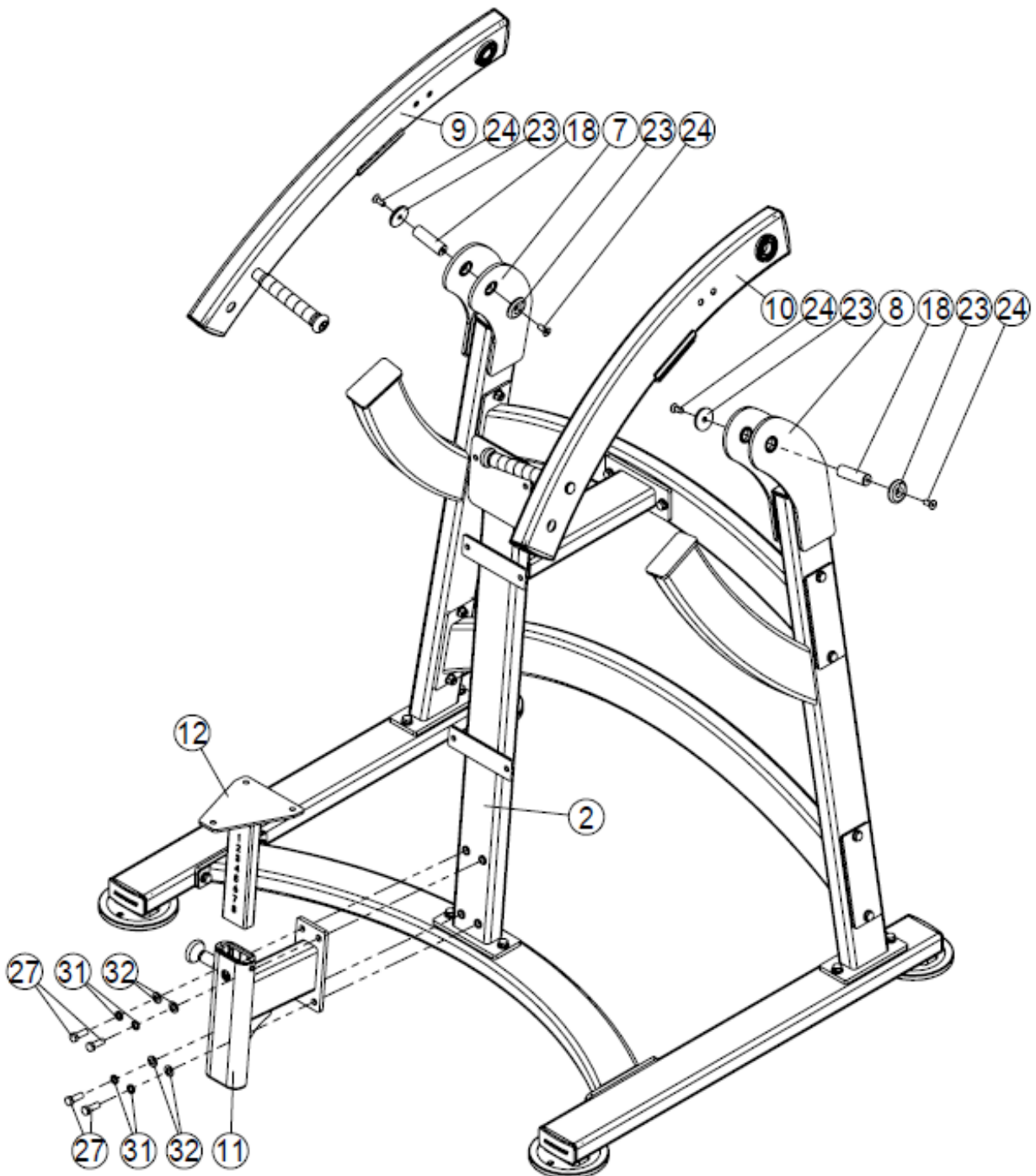



# Maintenance Schedule

ROUTINE	COMMERCIAL MAINTENANCE	HOME MAINTENANCE	LATEST DATE ENTRY					
Inspect: Links, Pull Pins, Snap Locks, Swivels, Weight Stack Pins	DAILY	WEEKLY						
Clean: Upholstery	DAILY	WEEKLY						
Inspect: Cables or Belts and their tension	DAILY	WEEKLY						
Inspect: Accessory Bars, and Handles	WEEKLY	3 MONTHS						
Inspect: All Decals	WEEKLY	3 MONTHS						
Inspect: All Nuts and Bolts, Tighten if needed	WEEKLY	3 MONTHS						
Inspect: Anti-skid Surface	WEEKLY	3 MONTHS						
Clean&Lubricate: Guide rods with a Teflon(PTFE) based lubricant(Superlube)	MONTHS	3 MONTHS						
Lubricate: Seat Sleeves, Turcite Bushings, Linear Bearing	MONTHS	3 MONTHS						
Clean and Wax: All Glossy Finishes	6 MONTHS	YEARLY						
Repack with Grease: Linear Bearings	6 MONTHS	YEARLY						
Replace: Cables, Belts and Connecting Parts	YEARLY	3 YEARS						

## **General Maintenance Information**

### **Links, Pull-Pins, Snap Hooks, Swivels, Weight Stack Pins:**

- \*Check all pieces for signs of visible wear or damage.
- \*Check springs in snap hooks and pull-pins for proper tension and alignment.
- \*If the spring sticks or has lost its rigidity, replace it immediately.

### **Upholstery:**

- \*To ensure prolonged upholstery life and proper hygiene, all upholstered pads should be wiped down with a damp cloth after every workout.
- \*Periodically take the time to use a mild soap or approved vinyl upholstery cleaner to deter the onset of cracking or drying. Avoid using any abrasive cleaners or cleaners not intended for use on vinyl.
- \*Replace ripped or worn upholstery immediately.
- \*Keep sharp or pointed objects clear of all upholstery.

### **Decals:**

- \*Inspect and familiarize yourself with any safety warnings or other user information posted on each decal.

### **Nuts and Bolts:**

- \*Inspect all nuts and bolts for any loosening and tighten if needed.
- \*Go through a re-tightening sequence periodically to ensure that all hardware is tensioned proper.

### **Anti-Skid Surfaces:**

- \*These surfaces are designed to supply secure footing and need to be replaced if they appear worn or become slippery.

### **Belts and Cables:**

- \*We use only high quality belt, and mil-spec cables.
- \*Visually inspect the belts and cables for fraying, cracking, peeling or discoloration.
- \*While the machine is not in use, carefully run your fingers along the belt or cable to feel for thinning or bulging areas.
- \*Replace belts and cables immediately at the first signs of damage or wear. Do not use equipment until belts or cables have been replaced.

### **Belt and Cable Tensions:**

- \*Referring to the Owner's Manual, when belts or cables are used check all bolts attachment to be sure they are properly attached.
- \*Check slack in cables and re-adjust cable tension if needed.

### **Seat Sleeves, Guide Rods:**

- \*Wipe down adjusting tubes with a dust free rag before applying lubricant.
- \*Lubricate seat sleeves and Guide Rods with silicon or Teflon based lubricant spray.

### **Linear Bearings:**

- \*Referring to the owner's manual carefully disassembly the bearing from its housing and place a finger full of light grease (lithium, super lube, etc) into the inside of the bearing. Use your finger, press the grease into the ball-bearings and their tracks. Repeat until the ball-bearing tracks are full

of grease. Insert the shaft back into the bearing and wipe off excess grease.

## **Weight Training Tips**

Use this manual to guide you through the basic exercises you can perform on your equipment. To gain maximum results and avoid possible injury, consult a fitness professional to develop your complete exercise program.

Always consult your physician before starting any exercise program.

To be successful in your exercise program, it is important to develop an understanding of the basic principles of strength training. Now that you have your equipment, it is only natural that you want to get started immediately. First, determine a set of realistic goals and objectives for yourself. By deciding on an exercise plan that is right for you prior to starting, you will contribute significantly to your success.

Warm up properly before engaging in weight resistance training. Stretching, yoga, jogging, calisthenics or other cardiovascular exercise can help prepare your body for the heavier workload of lifting weights.

Learn how to perform the exercise correctly before using heavy weight. Correct form is important to avoid injury and to ensure that you work the proper muscle groups.

Know your limitations. If you are new to weight training or are embarking on an exercise regimen after a long layoff, start slowly and build foundational strength over a longer period of time.

Pay attention to your breathing. Exhale when you exert is a general rule of thumb. Never hold your breath.

## **Specifications**

Class: S

Maximum Load of Trainer: 150Kgs/330Lbs



***BODYTONE***

[www.bodytone.eu](http://www.bodytone.eu)